



CATÁLOGO DE TORNILLOS

MÁXIMO RENDIMIENTO - DURABILIDAD SUPERIOR



APLICACIÓN
FRACO

DISEÑO DE PRECISIÓN - CALIDAD GARANTIZADA

RECOMENDACIONES DE INSTALACIÓN

Antes de instalar los tornillos FRACO verifique:

1. • El hilo de rosca del alojamiento, eliminando cualquier impureza que aumente la fricción y consuma torque. (Use un macho según el diámetro e hilo de rosca).









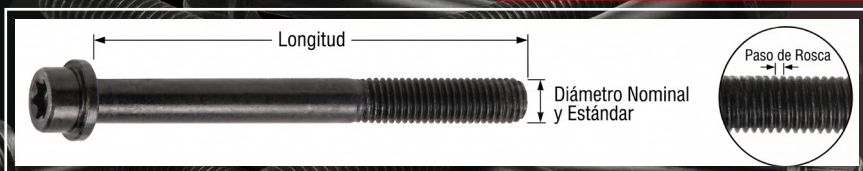





2. Con aire a presión retira cualquier impureza del alojamiento.

NOTA: Los líquidos causan trabas hidráulicas que son consumidoras de torque.

3. Lubricar los tornillos, media hora antes para evitar excesos de aceite.



NOTA: No hay conversión de libras, newtons o kilogramos a GRADOS. Aplique el torque sugerido con la herramienta correcta



MARCA	MODELO	REFERENCIA	MOTOR	AÑOS	PÁG.
 	AVEO	BH-1286	F16D3 / LEW-LQW	05-15 / 02-13	3
	NUBIRA / LANOS	BH-1286	A16DMS	98-02	3
	SILVERADO / TAHOE / CHEYENNE / AVALANCHE	BH-9292	VORTEC	06-15	4
	OPTRA DESIGN	BH-1288	DESIGN DOHC	05-12	5
	LUV D-MÁX	BH-1253	6VD1 / 6VE1	04-14	6
	TRAIL BLAZER	BH-7734	4.2	02-09	7
	CORSA CHEVY	BH-9410	16 NE	00-06	8
	OPTRA LIMITED	BH-1289	LIMITED	05-12	9
	EXPLORER	BH-9276	3.5	12-19	10
	FIESTA / KA / ECOSPORT	BH-23009	ZETEC / ROCAM	99-12	11
	ESCAPE / FUSION	BH-23012	DURATEC	01-08	12
 	SPORTAGE	BH-8703	G4GC 16 VAL	05-10	13
	TUCSON / ELANTRA	BH-8703	G4GC 16 VAL	05-10	13
 HYUNDAI	GETZ / ACCENT	BH-8701	G4EK	90-06	14
	GETZ / ELANTRA / VERNA	BH-8704	G4ED DOHC 16 VAL	06-13	15
 	RAM	BH-9899	HEMI	05-07	16
	GRAND CHEROKEE 4G	BH-9899	HEMI	11-18	16
	CHEROKEE / LIBERTY	BH-1274	KK / KJ	05-15	17
	LANCER / SIGNO	BH-4304	CB1 / CB2 / CK1 / CK2 / CS3	92-16	18
	ARAUCA / X1 / ORINOCO / TIGGO	BH-7502	SQR473F SQR481FC	12-18	19
	TWINGO 16 VAL	BH-3111	D4F	99-06	20
	GOL / PARATI / SAVEIRO	BH-6500	AP	00-08	21
	HI-LUX KAVAK / FORTUNER / FJ CRUISER / 4 RUNNER	BH-8610	1GR-FE	03-15	22

ESPECIFICACIONES TÉCNICAS

Diámetro y Estándar	Longitud (mm)	Paso de Rosca (mm)	Cantidad (Unid.)
M10	166	1.25	10

MARCA	  OEM: 81021200
APLICACIÓN	AVEO NUBIRA / LANOS
LTS.	1.6 / 1.8
CIL.	4L
MOTOR	F16D3 / LEW-LQW A16DMS
AÑOS	05-15 / 02-13 98-02

ORDEN DE APRIETE:

GM AVEO
 1er. apriete 18 (LB/PIE)
 2do. 70°
 3er. 70°
 4to. 50°

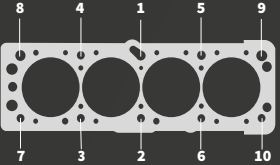

GM CRUZE
 1er. apriete 18 (LB/PIE)
 2do. 90°
 3er. 90°
 4to. 90°
 5to. 45°

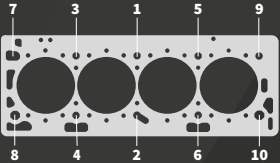

DAEWOO NUBIRA
 1er. apriete 18 (LB/PIE)
 2do. 70°
 3er. 70°
 4to. 50°

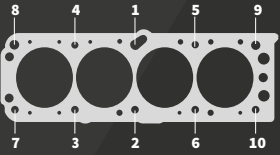

ESPECIFICACIONES TÉCNICAS

Diámetro y Estándar	Longitud (mm)	Paso de Rosca (mm)	Cantidad (Unid.)
M11/M8	100 / 45	2.0 / 1.25	15 <small>10 LARGOS 05 CORTOS</small>

MARCA		OEM: 19258707
APLICACIÓN	SILVERADO / TAHOE / CHEYENNE / AVALANCHE	
LTS.	5.3	
CIL.	8V	
MOTOR	VORTEC	
AÑOS	06-15	

ORDEN DE APRIETE:

**GM SILVERADO / TAHOE /
CHEYENNE / AVALANCHE**

1er. apriete 20 (LB/PIE)
2do. apriete 40 (LB/PIE)
3er. apriete 75 (LB/PIE)

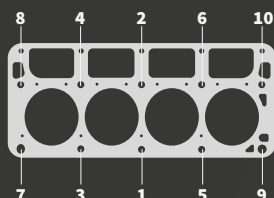

IZQUIERDA

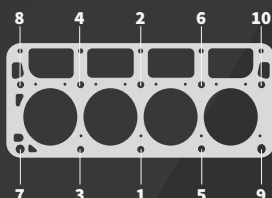

DERECHA

ESPECIFICACIONES TÉCNICAS

Diámetro y Estándar	Longitud (mm)	Paso de Rosca (mm)	Cantidad (Unid.)
M10	156	1.25	10

MARCA	 OEM: 81060500
APLICACIÓN	OPTRA DESIGN
LTS.	1.8
CIL.	4L
MOTOR	DESIGN DOHC
AÑOS	05-12

ORDEN DE APRIETE:

GM OPTRA DESIGN

- 1er. apriete 18 (LB/PIE)
- 2do. 70°
- 3er. 70°
- 4to. 50°

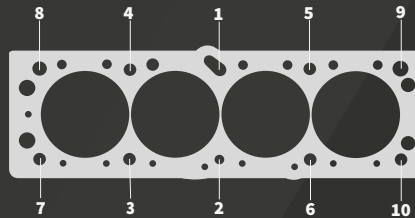

ESPECIFICACIONES TÉCNICAS

Diámetro y Estándar	Longitud (mm)	Paso de Rosca (mm)	Cantidad (Unid.)
M11	155	1.5	16

MARCA		OEM: 8970119982
APLICACIÓN	LUV D-MÁX	
LTS.	3.5	
CIL.	6V	
MOTOR	6VD1 / 6VE1	
AÑOS	04-14	

ORDEN DE APRIETE:

GM LUV D-MÁX

1er. apriete 20 (LB/PIE)
2do. apriete 59 (LB/PIE)
3er. 85°

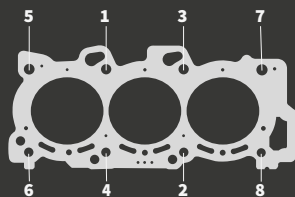

IZQUIERDA

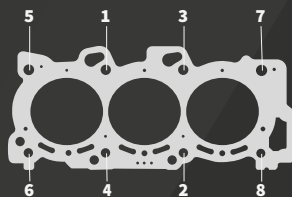

DERECHA

ESPECIFICACIONES TÉCNICAS

Diámetro y Estándar	Longitud (mm)	Paso de Rosca (mm)	Cantidad (Unid.)
M11	145	2.0	17 14 LARGOS 01 MEDIANO 02 CORTOS

MARCA		OEM: ES71334
APLICACIÓN	TRAIL BLAZER	
LTS.	4.2	
CIL.	6L	
MOTOR	4.2	
AÑOS	02-09	

ORDEN DE APRIETE:

GM TRAIL BLAZER

- 1er. apriete T1-14 22 (LB/PIE)
- 2do. T1-14 +150°
- 3er. apriete T16-17 62 (LB/PIE) + 50°
- 4to. apriete T15 62 (LB/PIE) + 120°

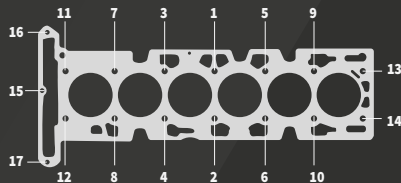

ESPECIFICACIONES TÉCNICAS

Diámetro y Estándar	Longitud (mm)	Paso de Rosca (mm)	Cantidad (Unid.)
M10	140	1.25	10

MARCA	 OEM: 81004800
APLICACIÓN	CORSA CHEVY
LTS.	1.6
CIL.	4L
MOTOR	16 NE
AÑOS	00-06

ORDEN DE APRIETE:

GM CORSA CHEVY

- 1er. apriete 15 (LB/PIE)
- 2do. apriete 29 (LB/PIE)
- 3er. apriete 60(LB/PIE)

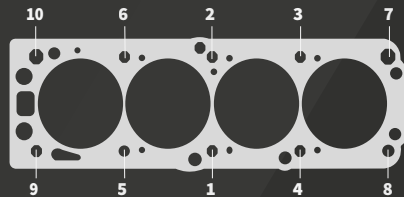

ESPECIFICACIONES TÉCNICAS

Diámetro y Estándar	Longitud (mm)	Paso de Rosca (mm)	Cantidad (Unid.)
M11	105	1.25	10

MARCA		OEM: 81017500
APLICACIÓN	OPTRA LIMITED	
LTS.	1.8	
CIL.	4L	
MOTOR	LIMITED	
AÑOS	05-12	

ORDEN DE APRIETE:

GM OPTRA LIMITED

- 1er. apriete 18 (LB/PIE)
- 2do. 70°
- 3er. 70°
- 4to. 50°

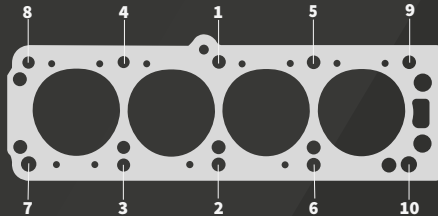

ESPECIFICACIONES TÉCNICAS

Diámetro y Estándar	Longitud (mm)	Paso de Rosca (mm)	Cantidad (Unid.)
M11	131.5	1.5	8

MARCA	 OEM: 81071400
APLICACIÓN	EXPLORER
LTS.	3.5
CIL.	6V
MOTOR	3.5
AÑOS	12-19

ORDEN DE APRIETE:

FORD EXPLORER 1er. apriete 26 (LB/PIE)
 2do. 90°
 3er. 90°
 4to. 90°

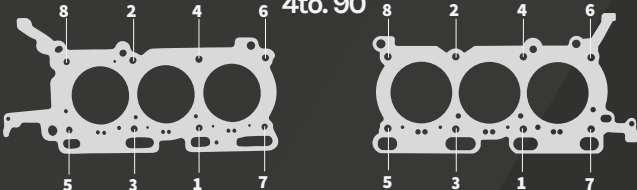

IZQUIERDA **DERECHA**

ESPECIFICACIONES TÉCNICAS

Diámetro y Estándar	Longitud (mm)	Paso de Rosca (mm)	Cantidad (Unid.)
M11 / M8	164 / 49	1.5 / 1.25	12 ^{10 LARGOS} ^{02 CORTOS}

MARCA	 OEM: 81033900
APLICACIÓN	FIESTA / KA / ECOSPORT
LTS.	1.6
CIL.	4L
MOTOR	ZETEC - ROCAM
AÑOS	99-12

ORDEN DE APRIETE:

FORD FIESTA / ECOSPORT / KA

- 1er. apriete 22 (LB/PIE)
- 2do. -90°
- 3er. apriete 22 (LB/PIE)
- 4to. 90°
- 5to. 90°

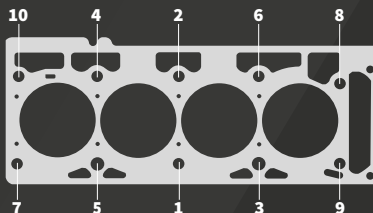

ESPECIFICACIONES TÉCNICAS

Diámetro y Estándar	Longitud (mm)	Paso de Rosca (mm)	Cantidad (Unid.)
M10	154	1.5	16

MARCA	 OEM: 81048000
APLICACIÓN	ESCAPE / FUSION
LTS.	3.0
CIL.	6V
MOTOR	DURATEC
AÑOS	01-08

ORDEN DE APRIETE:

FORD ESCAPE / FUSION

- 1er. apriete 15 (LB/PIE)
- 2do. apriete 29 (LB/PIE)
- 3er. 90°
- 4to. 180°
- 5to. apriete 29 (LB/PIE)
- 6to. 90°
- 7mo. 90°

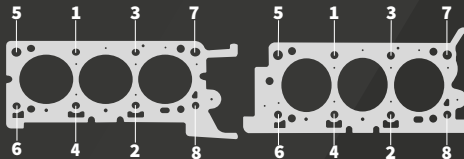

IZQUIERDA

DERECHA

ESPECIFICACIONES TÉCNICAS

Diámetro y Estándar	Longitud (mm)	Paso de Rosca (mm)	Cantidad (Unid.)
M10/M12	99 / 151	1.25	10 ^{02 LARGOS} _{08 CORTOS}

MARCA	 OEM: 81020800
APLICACIÓN	TUCSON / ELANTRA SPORTAGE
LTS.	2.0
CIL.	4L
MOTOR	G4GC 16 VAL
AÑOS	05-10

ORDEN DE APRIETE:

**HYUNDAI TUCSON / ELANTRA
 KIA SPORTAGE**

- 1er. apriete 18 (LB/PIE)
- 2do. -90°
- 3er. apriete 18 (LB/PIE)
- 4to. 60°
- 5to. 60°

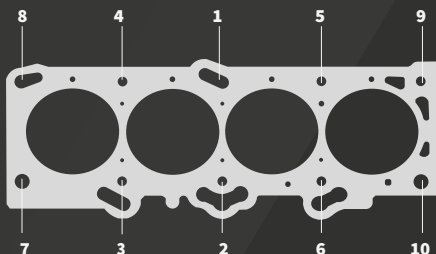

ESPECIFICACIONES TÉCNICAS

Diámetro y Estándar	Longitud (mm)	Paso de Rosca (mm)	Cantidad (Unid.)
M10	106	1.25	10

MARCA	 HYUNDAI	OEM: 81034000
APLICACIÓN	GETZ / ACCENT	
LTS.	1.3 / 1.5	
CIL.	4L	
MOTOR	G4EK	
AÑOS	90-06	

ORDEN DE APRIETE:

HYUNDAI GETZ / ACCENT

- 1er. apriete 18 (LB/PIE)
- 2do. -90°
- 3er. apriete 18 (LB/PIE)
- 4to. 60°
- 5to. 60°

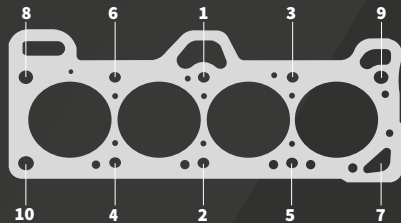

ESPECIFICACIONES TÉCNICAS

Diámetro y Estándar	Longitud (mm)	Paso de Rosca (mm)	Cantidad (Unid.)
M10	95	1.25	10

MARCA	 HYUNDAI	OEM: 81029900
APLICACIÓN	GETZ / ELANTRA / VERNA	
LTS.	1.6	
CIL.	4L	
MOTOR	G4ED DOHC 16 VAL	
AÑOS	06-13	

ORDEN DE APRIETE:

HYUNDAI GETZ / ELANTRA / VERNA

- 1er. apriete 18 (LB/PIE)
- 2do. 70°
- 3er. 70°
- 4to. 50°

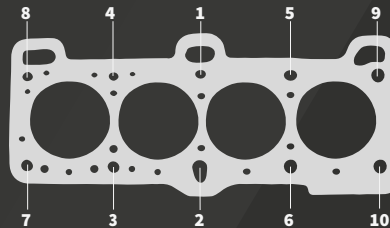

ESPECIFICACIONES TÉCNICAS

Diámetro y Estándar	Longitud (mm)	Paso de Rosca (mm)	Cantidad (Unid.)
M12 / M8	133.7 / 44	1.5 / 1.25	15 ^{10 LARGOS} _{05 CORTOS}

MARCA	 OEM: 81076700
APLICACIÓN	GRAND CHEROKEE 4G RAM
LTS.	5.7
CIL.	8V
MOTOR	HEMI
AÑOS	11-18 05-07

ORDEN DE APRIETE:

**JEEP GRAND CHEROKEE 4G
 DODGE RAM**

- 1er. apriete 25 (LB/PIE)
- 2do. apriete 50 (LB/PIE)
- 3er. apriete 105 (LB/PIE)

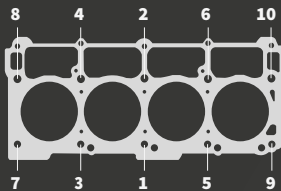

IZQUIERDA

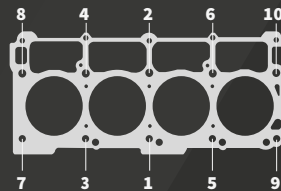

DERECHA

ESPECIFICACIONES TÉCNICAS

Diámetro y Estándar	Longitud (mm)	Paso de Rosca (mm)	Cantidad (Unid.)
M11	171 / 29.5	1.5	12 08 LARGOS 04 CORTOS

MARCA	Jeep	OEM: 81052300
APLICACIÓN	CHEROKEE LIBERTY	
LTS.	3.7	
CIL.	6V	
MOTOR	KK / KJ	
AÑOS	05-15	

ORDEN DE APRIETE:

JEEP CHEROKEE LIBERTY

1er. apriete 20 (LB/PIE)
2do. apriete 59 (LB/PIE)
3er. 85°

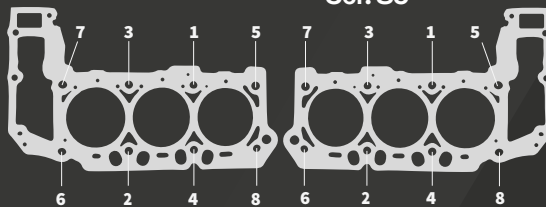

IZQUIERDA

DERECHA

ESPECIFICACIONES TÉCNICAS

Diámetro y Estándar	Longitud (mm)	Paso de Rosca (mm)	Cantidad (Unid.)
M9	101	1.25	10

MARCA	 OEM: MD35550
APLICACIÓN	LANCER / SIGNO
LTS.	1.3 / 1.5 / 1.6
CIL.	4L
MOTOR	CB1 / CB2 / CK1 / CK2 / CS3
AÑOS	92-16

ORDEN DE APRIETE:

MITSUBISHI LANCER

1er. apriete 20 (LB/PIE)
2do. apriete 40 (LB/PIE)
3er. apriete 55 (LB/PIE)

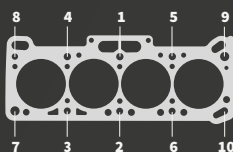

MITSUBISHI LANCER

1er. apriete 22 (LB/PIE)
2do. apriete 43 (LB/PIE)
3er. apriete 62 (LB/PIE)

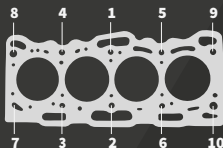

MITSUBISHI LANCER / SIGNO

1er. apriete 22 (LB/PIE)
2do. apriete 43 (LB/PIE)
3er. apriete 62 (LB/PIE)

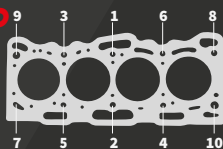

ESPECIFICACIONES TÉCNICAS

Diámetro y Estándar	Longitud (mm)	Paso de Rosca (mm)	Cantidad (Unid.)
M10	157	1.5	10

MARCA	 CHERY	OEM: 481H-1003082
APLICACIÓN	ARAUCA / X1 ORINICO / TIGGO	
LTS.	1.3 / 1.8 / 2.0	
CIL.	4L	
MOTOR	SQR473F SQR481FC	
AÑOS	12-18	

ORDEN DE APRIETE:

CHERY ARAUCA / X1

- 1er. apriete 22 (LB/PIE)
- 2do. apriete 43 (LB/PIE)
- 3er. apriete 62 (LB/PIE)

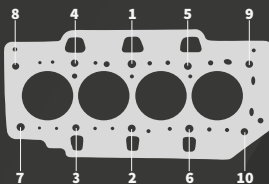

CHERY ORINOCO / TIGGO

- 1er. apriete 40 (LB/PIE)
- 2do. 90°
- 3er. 90°

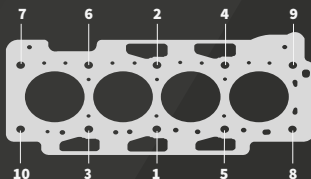

ESPECIFICACIONES TÉCNICAS

Diámetro y Estándar	Longitud (mm)	Paso de Rosca (mm)	Cantidad (Unid.)
M9	122	1.25	10

MARCA	 RENAULT OEM: 81031700
APLICACIÓN	TWINGO 16 VAL
LTS.	1.2
CIL.	4L
MOTOR	D4F
AÑOS	99-06

ORDEN DE APRIETE:

RENAULT TWINGO 16 VAL

1er. apriete 15 (LB/PIE)
 2do. +115°
 3er. +115°

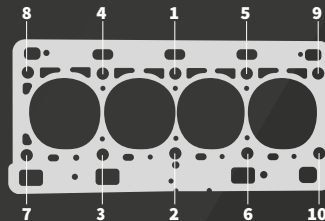

ESPECIFICACIONES TÉCNICAS

Diámetro y Estándar	Longitud (mm)	Paso de Rosca (mm)	Cantidad (Unid.)
M11	98	1.5	10

MARCA		OEM: 81046300
APLICACIÓN	GOL / PARATI / SAVEIRO	
LTS.	1.8	
CIL.	4L	
MOTOR	AP	
AÑOS	00-08	

ORDEN DE APRIETE:

VOLKSWAGEN GOL / PARATI / SAVEIRO

- 1er. apriete 29(LB/PIE)
- 2do. apriete 43 (LB/PIE)
- 3er. 90°
- 4to. 90°

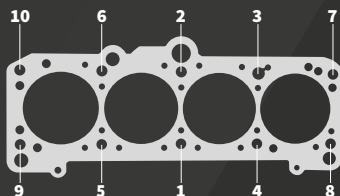

ESPECIFICACIONES TÉCNICAS

Diámetro y Estándar	Longitud (mm)	Paso de Rosca (mm)	Cantidad (Unid.)
M11	155.5	1.5	16

MARCA	 TOYOTA	OEM: 90910-02162
APLICACIÓN	HI-LUX KAVAK/FORTUNER/ FJ CRUISER / 4 RUNNER	
LTS.	4.0	
CIL.	6V	
MOTOR	1GR-FE	
AÑOS	03-15	

ORDEN DE APRIETE:

**TOYOTA HI-LUX KAVAK /
FORTUNER / FJ CRUISER /
4 RUNNER**

1er. apriete 27 (LB/PIE)
2do. +180° GIRO

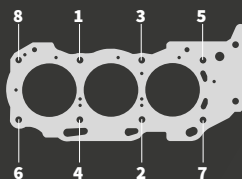

IZQUIERDA

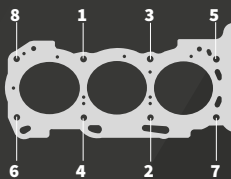

DERECHA



G A S K E T S®

FRACO

OIL SEALS

CATÁLOGO DE TORNILLOS

